



Z2FS6...type Modular Restrictive Check Valve



Z2FS6...4XJ...type

Size 6
Max. Working Pressure: 315 bar
Max. Flow: 80 L/min

Contents

Function and configurations	02
Specifications	03
Symbols	03
Technical data	04
Characteristic curves	04
Unit dimensions	05

Features

- Sandwich plate valve
- Porting pattern to DIN 24 340 form A and ISO4401
- 3 adjustment elements:
 - Screw with locknut and protective cap
 - Two insert pressure relief valve
 - Rotary knob with scale
- For limiting the main or pilot fluid flow of 2 actuator connections
- For meter-in or meter-out control

Function and configuration

Z2FS6 type valve is a double throttle check valve with sandwich plate structure. It is used for the main or pilot flow limitation of one or two actuator ports. In the opposite direction, fluid flows freely through the check valve.

For meter-in control fluid passes from port A1 to port A2 via the throttling point (1), which is made up of the valve seat (2) and the throttling spool (3). The throttling spool (3) is axially adjustable through the adjustment screw (4).

Fluid flows from A2 to A1, valve seat (2) is opened against spring (5) and valve acts as check valve. Depending on the installation position, the throttling effect may be arranged as a meter-in or a meter-out control.

Main flow limitation(Z2FS6.../2Q)

In order to change the velocity of an actuator (limiting of main flow), the double throttle/check valve is installed between the directional valve and the sub-plate.

Pilot flow limitation(Z2FS6.../1Q)

In order to limit the pilot flow, the double throttle/check valve is installed between the main valve and the pilot valve.

04

Type: Z2FS6-2-4XJ/2Q

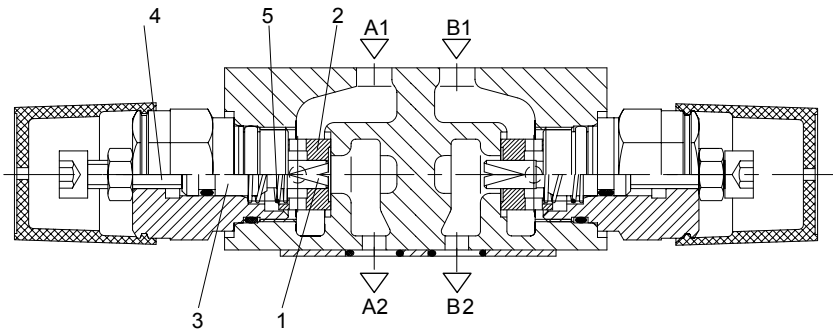

This installed position is for meter-in control

Specification

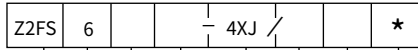

Modular restrictive check valve	
Nominal size 6	=6
Throttle/check valve ports A and B	= -
Throttle/check valve port A	= A
Throttle/check valve port B	= B
Screw with locknut and protective cap	= 2
Lockable rotary knob with scale	= 3
Rotary knob with scale	= 7

Further details in clear text	
No code =	NBR seals
V =	FKM seals
1Q =	With fine control
2Q =	Standard version
4XJ =	Series 40J to 49J (40J to 49J: unchanged installation and connection dimensions)

Symbols (① = valve side, ② = sub-plate side)

Type:Z2FS6-...-4XJ/ (meter-in control)

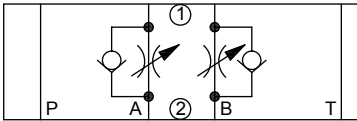

Type:Z2FS6-...-4XJ/ (meter-out control)

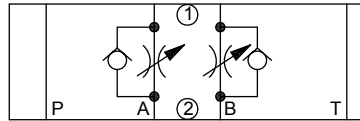

Type:Z2FS6A-...-4XJ/ (meter-in control)

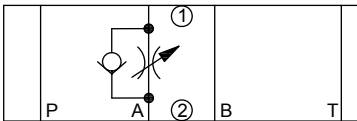

Type:Z2FS6A-...-4XJ/ (meter-out control)

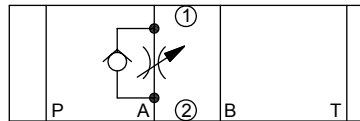

Type:Z2FS6B-...-4XJ/ (meter-in control)

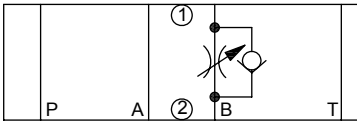

Type:Z2FS6B-...-4XJ/ (meter-out control)

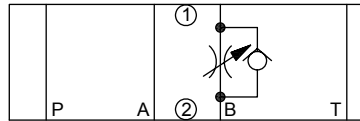

Technical data

Fluid		Mineral oil suitable for NBR and FKM seal Phosphate ester for FKM seal
Fluid temperature range	°C	-30 to +80 (NBR seal) -20 to +80(FKM seal)
Viscosity range	mm ² /s	10 to 800
Degree of contamination		Maximum permissible degree of fluid contamination: Class 9. NAS 1638 or 20/18/15, ISO4406
Max. working pressure	bar	315
Max. flow-rate	L/min	80
Weight	kg	Approx.1.0

Characteristic curves

(Measured at t=40°C ±5°C , using HLP46)

ΔP-Q_v curve-Z2FS6-...-4XJ/2QV

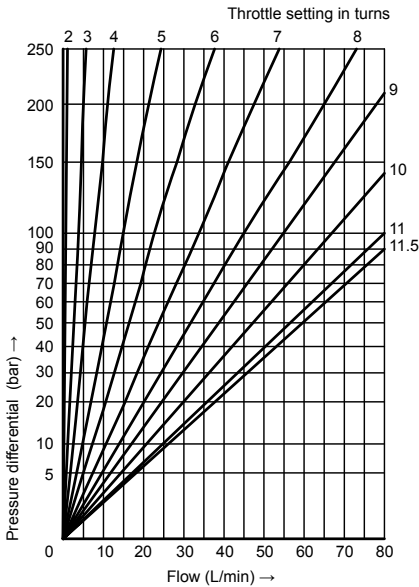

ΔP-Q_v curve-Z2FS6-...-4XJ/1QV

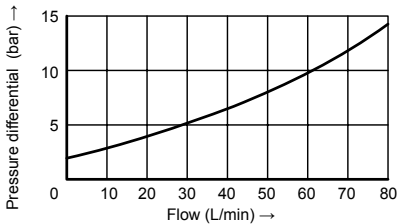
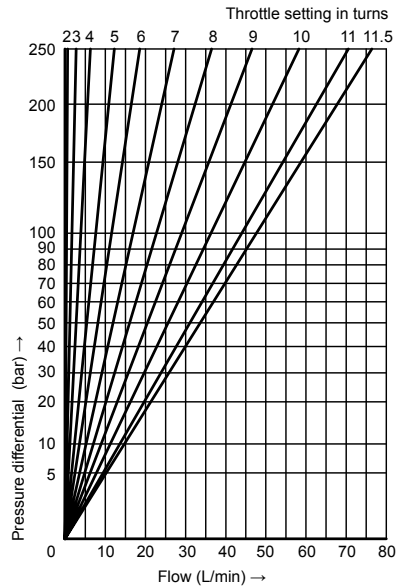

Through check valve (throttle closed)

Unit dimensions

(Dimensions in mm)

Type: Z2FS6A-...-4XJ/ ...

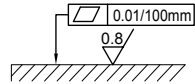
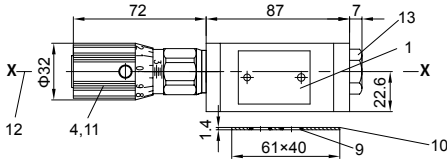

Requirement for mounting surface

Type: Z2FS6B-...-4XJ/...

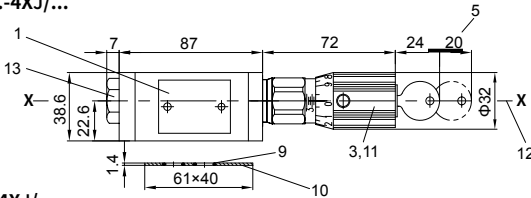

Type: Z2FS6-...-4XJ/ ...

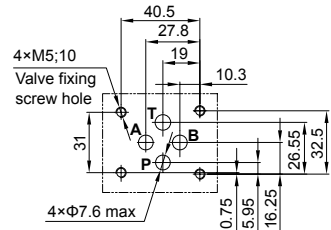
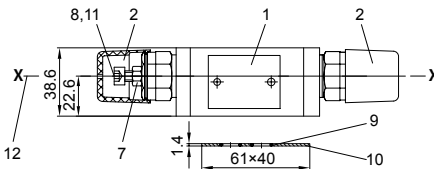

Dimensions of mounting surface

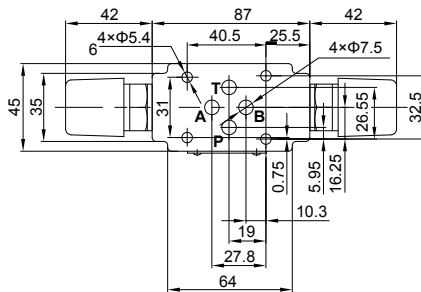

- 1 Nameplate
- 2 Adjustment element "2"
- 3 Adjustment element "3"
- 4 Adjustment element "7"
- 5 Space required to remove the key
- 6 Valve fixing holes
- 7 Lockable nut S=10
- 8 Internal hexagon screw S=5
- 9 O-rings 9.25×1.78 (Port A, B, P, T)
- 10 O-ring plate
- 11 For all adjustment elements:
turn anti-clockwise=increases flow
turn clockwise=decreases flow
- 12 To change from meter-in to meter-out,
rotate the unit around the 'X-X' axis
- 13 End cap S=22