



DZ...type Pilot Operated Sequence Valve



DZ...5XJ...type

Sizes 10, 25, 32
Max. Working Pressure: 315 bar
Max. Flow: 600 L/min

Contents

Function and configuration	02
Symbols	03
Specifications	03
Technical data	04
Characteristic curves	04
Unit dimensions	05-06

Features

- Sub-plate mounting
- Conforms to DIN 24 340, form D, and ISO 5781
- Manifold plate mounting
- 4 pressure ratings
- 4 adjustment elements:
 - Rotary knob
 - Adjustable bolt with protective cap
 - Lockable rotary knob with scale
 - Rotary knob with scale
- Check valve, optional

Function and configuration

DZ type valve is a pilot operated pressure sequence valves. It is used for pressure dependent sequence switching of a secondary circuit.

The valve consists of main valve (1) with main spool insert (7) , pilot valve (2) with pressure adjustment element and optional check valve (3).

According to the Pilot Oil supply and return, the function you distinguish between:

•Type DZ...-5XJ/.....

(Control lines 4.1, 12 and 13 open; control lines 4.2, 14 and 15 plugged) The pressure in port A acts on the pilot spool (5) of the pilot valve (2) via the control line (4.1). At the same time it acts on the spring loaded side of the main spool (7) via orifice(6). When the pressure exceeds the setting value of spring (8), the pilot spool (5) is moved against the spring (8). The fluid on the spring loaded side of the main spool (7) flows to port B via orifice (9), control land (10) and control lines (11) and (12). There is now a pressure drop at main spool (7), the connection from port A to port B opens to maintain the pressure set by spring (8). The leakage oil at pilot spool (5) is led to port B internally via control line(13). An optional check valve (3) can be fitted for free flow from port B to A.

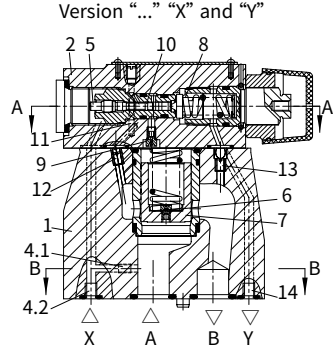

•Sequence valveType DZ...-5XJ/...X..

(Control lines 4.2, 12 and 13 open; control lines 4.1, 14 and 15 plugged) The function of this valve is principally the same as valve DZ...-5XJ/....However, on pressure sequence valve type DZ...-5XJ/...X.. the signal is achieved externally by means of control line (4.2).

•Sequence valve Type DZ...-5XJ/...Y..

(Control lines 4.1, 12 and 14 or 15 open; control lines 4.2, and 13 plugged) The function of this valve is principally the same as valve type DZ...-5XJ/....However, for type DZ...-5XJ/...Y.. leakage at pilot spool(5) must be drained to tank without pressure via line (14) or(15) . Pilot oil is fed to port B via line(12) .

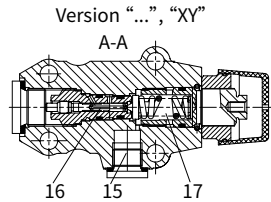

•Bypass valve Type DZ...-5XJ/...XY..

(Control lines 4.2 14 or 15 open; control lines 4.1, 12 and 13 plugged) Pressure in port X acts on the pilot spool (5) in the pilot valve (2) via control line (4.2). At the same time pressure in port A acts on the spring loaded side of the main spool (7) via orifice (6). When the pressure in port X exceeds the setting value of the spring (8), the pilot spool(5) is moved against the spring (8), fluid can flow from the spring loaded side of the main spool (7) into the spring chamber (17) of the pilot valve (2) via orifice (9) and line (16) and pressure decreases on the spring loaded side of the main spool (7).The fluid can, therefore, flow from port A to B with minimum pressure loss. The pilot oil in spring chamber (17) should be drained to tank without pressure via line (14) or (15). An optional check valve (3) can be fitted for free flow from port B to A.

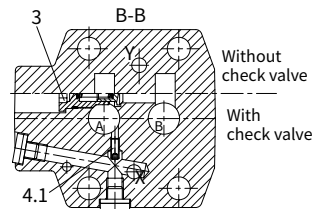

Symbols

DZ...5XJ/...M...
DZC...5XJ/...M...

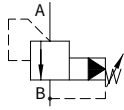

DZ...5XJ/...XM...

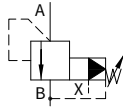

DZ...5XJ/...YM...

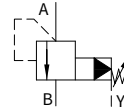

DZ...5XJ/...XYM...
DZC...5XJ/...XYM...

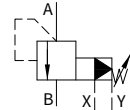

DZ...5XJ/...

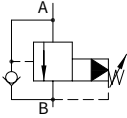

DZ...5XJ/...X...

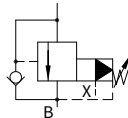

DZ...5XJ/...Y...

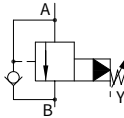

DZ...5XJ/...XY...

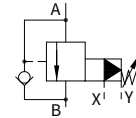

Specification

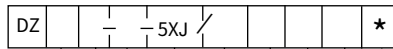

Pressure sequence valve, pilot operated	=No code
Pilot operated valve Without main spool assembly (No mark for size)	= C
Pilot operated valve With main spool assembly (Marked with size 30)	= C
Nominal size 10	=10
Nominal size 25	=20
Nominal size 32	=30
Rotary knob	=1
Adjustable bolt with protective cap	=2
Lockable rotary knob with scale	=3
Rotary knob with scale	=7
Series 50 to 59J (50J to 59J series: unchanged installation and connection dimensions)	=5XJ

Further details in clear text	
No code =	NBR seals
V =	FKM seals
No code =	With check valve
M =	Without check valve
No code =	Pilot oil supply and drain internal
X =	Pilot oil supply external and drain internal
Y =	Pilot oil supply internal and drain external
XY =	Pilot oil supply and drain external

50 =	Max. secondary pressure 50 bar
100 =	Max. secondary pressure 100 bar
200 =	Max. secondary pressure 200 bar
315 =	Max. secondary pressure 315 bar

Technical data

Fluid		Mineral oil suitable for NBR and FKM seal Phosphate ester for FKM seal			
Fluid temperature range		°C	-30 to +80 (NBR seal) -20 to +80 (FKM seal)		
Viscosity range		mm ² /s	10 to 800		
Degree of contamination		Maximum permissible degree of fluid contamination: Class 9. NAS 1638 or 20/18/15, ISO4406			
Max. operating pressure	Port A, B, X	bar	315		
	Port Y	bar	315		
Adjustable pressure	Max.	bar	50;100;200;315		
	Min.	bar	Interrelated to the flow (refer to the characteristic curve)		
Size			DZ10	DZ20	DZ30
Max. flow-rate		L/min	200	400	600
Fixing position		Optional			
Size			DZ10	DZ20	DZ30
Weight	sub-plate mounting DZ	kg	Approx.3.6	Approx.5.5	Approx.8.2
	DZC	kg	Approx.1.2		
	DZC30	kg	Approx.1.5		

Characteristic curves (Measured at $t=40^{\circ}\text{C} \pm 5^{\circ}\text{C}$, using HLP46)

Inlet pressure in relation to flow (A → B)

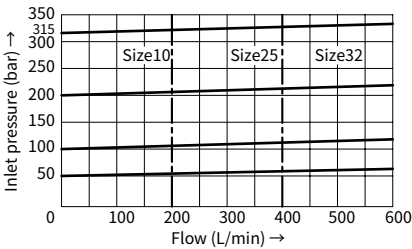

**Bypass pressure in relation to flow (A → B)
(only for version "...XY...")**

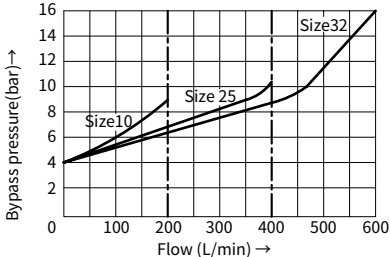

The curves are valid for outlet pressure $P_B=0$ for the complete flow range

**Minimum inlet pressure in relation to flow (A → B)
(= bypass pressure model "...X...")**

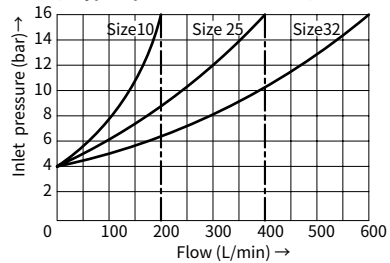

The curves are valid for outlet pressure $P_B=0$ for the complete flow range

**ΔP -Q Characteristic curves
via check valve (B → A)**

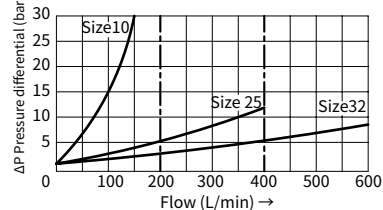

Unit dimensions

(Dimensions in mm)

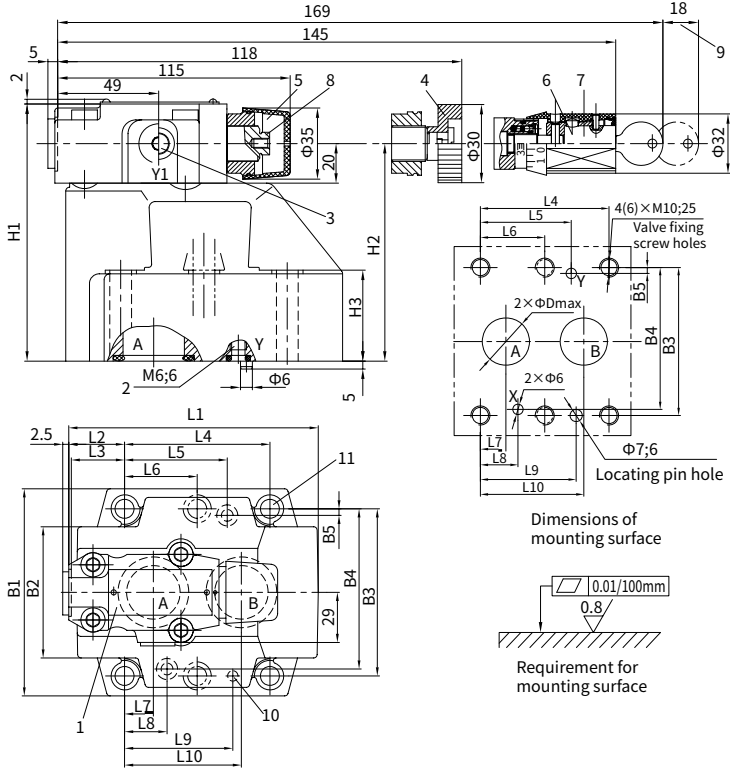

- 1 Nameplate
- 2 Port Y used for control oil drain external for use as bypass valve
- 3 Port Y1(G1/4;12) for control external drain when used as bypass valve, for unloading of spring chamber when used as sequence valve
- 4 Adjustment element "1"
- 5 Adjustment element "2"
- 6 Adjustment element "3"
- 7 Adjustment element "7"
- 8 Internal hexagon screw S=10
- 9 Space required to remove the key
- 10 Locating pin
- 11 Valve fixing holes 4pcs (DZ10, DZ20); 6pcs(DZ30)

Type	B1	B2	B3	B4	B5	O-ring(PortA,B)				O-ring(PortX,Y)				D
DZ10	85	50	66.7	58.8	7.9	17.12×2.62				9.25×1.78				13
DZ20	102	59.5	79.4	73	6.4	28.17×3.53				9.25×1.78				22
DZ30	120	76	96.8	92.8	3.8	34.52×3.53				9.25×1.78				30
Type	L1	L2	L3	L4	L5	L6	L7	L8	L9	L10	H1	H2	H3	
DZ10	96	35.5	33	42.9	21.5	-	7.2	21.5	31.8	35.8	112	92	28	
DZ20	116	37.5	35.4	60.3	39.7	-	11.1	20.6	44.5	49.2	122	102	38	
DZ30	145	33	29.8	84.2	59.5	42.1	16.7	24.6	62.7	67.5	130	110	46	

Unit dimensions

(Dimensions in mm)

With (DZC 30) or without (DZC) main spool insert

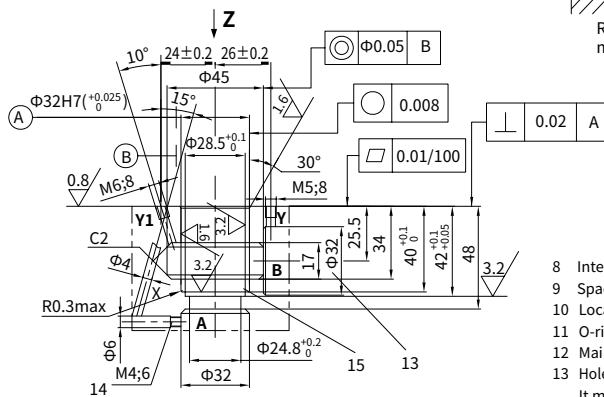
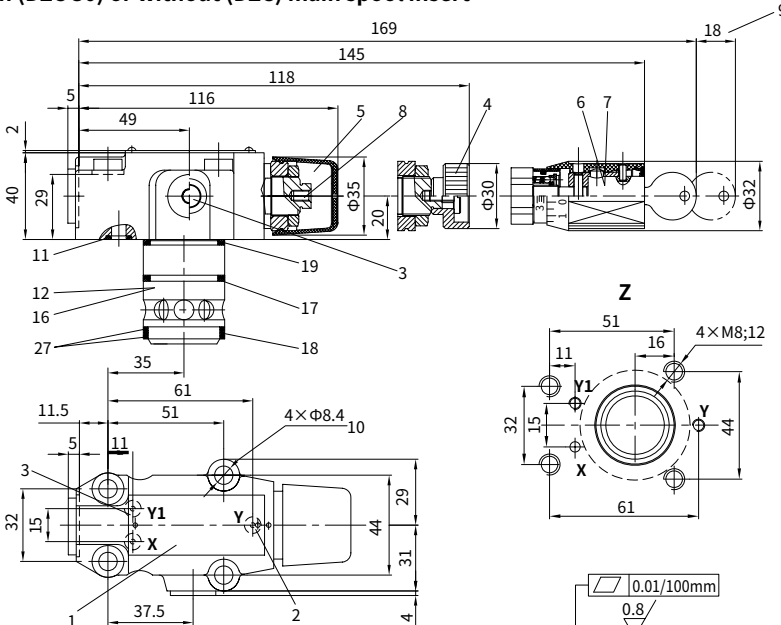

- 8 Internal hexagon bolt S=10
- 9 Space required to remove the key
- 10 Locating pin
- 11 O-ring 9.25×1.78
- 12 Main spool insert
- 13 Hole $\varnothing 32$ can meet hole $\varnothing 45$ at any location. It must care that connection hole X and the fixing hole are not damaged.
- 14 This drilling is not required when used as bypass valve
- 15 Back-up ring and O-ring to be inserted into this hole before fitting the main spool
- 16 Cartridge assembly includes main spool insert with throttle
- 17 O-ring 28×1.8
- 18 O-ring 27.3×2.4
- 19 O-ring 28×2.65
- 20 Back-up ring 28.4×32×0.8

- 1 Nameplate
- 2 Port Y for control oil external drain when used as bypass valve, for unloading of spring chamber when used as sequence valve
- 3 Port Y1 (G1/4; 12) used for control oil drain external when used as pressure control or sequence valve
- 4 Adjustment element "1"
- 5 Adjustment element "2"
- 6 Adjustment element "3"
- 7 Adjustment element "7"