



4WRZ(E)...type Electro-Hydraulic Proportional Directional Valve



4WRZ(E) and 4WRH...type

Size 10, 16, 25, 32

Max. Working Pressure: 315 bar

Max. Flow: 1600 L/min

Contents

Function and configuration	02-03
Ordering code	04
Symbols	05
Technical data	06
Electrical connections, plug-in connectors	07
Integrated electronics	07
Characteristic curves	08-11
Unit dimensions	12-15

Features

- Pilot operated proportional directional valve to control the direction and magnitude of a flow
- Operation is by proportional solenoids with central thread and detachable coil
- For subplate mounting:
 - Porting pattern to ISO 4401 and DIN 2430
- Spring centered control spool
- 4WRZE: Integrated electronics (OBE) with voltage input or current input (A1 resp. F1)
- 4WRZ: associated control electronics

Function and configuration

Pilot valve type 3DREP 6...

The pilot valve is a proportional solenoid operated 3-way pressure reducing valve. It is used to convert an electrical input signal into a proportional pressure output signal and is used on all 4WRZ...valves.

The proportional solenoids are controllable DC wet pin solenoid with central thread and detachable coil. The Solenoid is optionally controlled by external electronics (type WRZ...) or integrated electronics (type WRZE...).

The valve consists of valve housing(1), control spool(2) with pressure measuring spools(3 and 4), solenoids(5 and 6) with central thread, optionally with integrated electronics(8).

When the solenoids (5 and 6) are in the deenergized condition, the control spool (2) is held by compression springs in the central position.

Direct operation of the control spool (2) by energizing a proportional solenoid. Pressure measuring spool (3) and control spool (2) are shifted to the left in proportion to the electrical input signal; Connection from P to B and A to T through the orifice-like cross sections with progressive flow characteristics; De-energization of the solenoid (5), control spool (2) is returned to the central position by the compression spring, In the central position, ports A and B are open to T, i.e. the hydraulic fluid can flow to the tank without any restrictions.

An optional manual override can be used to move the control spool (2) without solenoid energization.

Pilot valve with two spool positions type 3DREP 6...B...

In principle, the function of this valve version corresponds to that of the valve with three spool positions. However, this 2-position valve is provided with solenoid "a" (5) only. Instead of the 2nd proportional solenoid, a plug screw (7) is fitted.

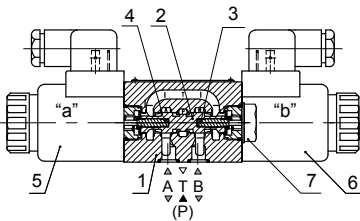

Type 3DREP6...

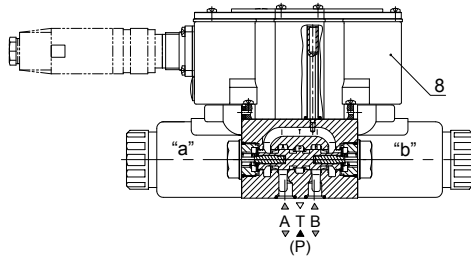

Type 3DREPE6...

Function and configuration

Pilot operated proportional directional valves Type 4WRZ...

4WRZ type valve is a pilot operated 4-way directional valves with operation by proportional solenoids. They control the direction and magnitude of a flow.

The valve consists of pilot valve (9) with proportional solenoids (5 and 6), control spool (2) and orifice plugs (15), main valve (10) with main spool (11) and centering spring (12).

When the solenoids (5 and 6) are de-energised, the main spool (11) is held by centering springs (12) in the central position.

Operation of the main spool (11) through the pilot valve(9), the main spool is moved proportionally, depending on the spool position, flow from P to A and B to T(R) or P to B and A to T(R). e.g. by energising solenoid "b" (6), the control spool (2) is shifted to the right, pilot oil is fed through the pilot valve (9) into the pressure chamber (13) and moves the main spool (11) in proportion to the electrical input signal; Connection from P to A and B to T through orifice-like cross-sections with progressive flow characteristics.

De-energization of the solenoid (6), the control spool (2) and main spool (11) are returned to the central position.

Pilot oil supply to the pilot valve internally via port P or externally via port X.

With the help of an optional manual override the control spool (2) can be moved without requiring the energization of the solenoid.

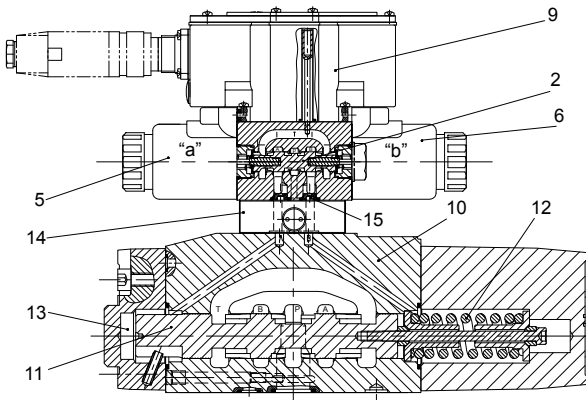

Type 4WRZE...

Ordering code

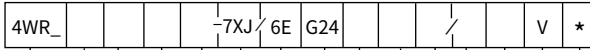

Hydraulic operation =H
 Electro-hydraulic =Z

For WRZ only:
 For external electronics= No code
 With integrated electronics =E

Nominal size 10 =10
 Nominal size 16 =16
 Nominal size 25 =25
 Nominal size 32 =32

Spool symbols

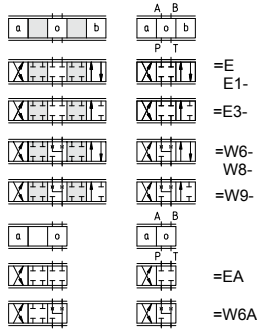

Nominal flow in L/min at a valve pressure differential $\Delta P=10\text{bar}$

25=	50=	85=	for size10
100=	150=		for size16
220=	325=		for size25
360=	520=		for size32

Further information in plain text

V = FKM
 No code = NBR

No code= Without pressure reducing valve
 D3=With pressure reducing valve:
 ZDR6DP0-L4X/40YM(fixed setting)

Interface A1 or F1 for WRZE
 A1= Command value input $\pm 10\text{V}$
 F1=Command value input 4 to 20mA

4WRZ: Z4= With plug-in connector
 K4= Without plug-in connector
 4WRZE: K31= Without plug-in connector
 Z31= With plug-in connector

No code= Pilot oil supply external
 Pilot oil drain external
 Pilot oil supply and drain
 Pilot oil supply internal
 Pilot oil drain external
 E= Pilot oil supply internal
 Pilot oil drain internal
 ET= Pilot oil supply internal
 Pilot oil drain internal
 T= Pilot oil supply external
 Pilot oil drain internal
 (for type 4WRH only possible with No code)

N9 = With protected hand override

Electronic control supply voltage
 Power supply voltage 24VDC

G24 =

6E = Proportional solenoid with removable coil

7XJ= Series 70J~79J
 (70J to 79J, unchanged installation and connection dimensions)

Symbols(simplified)

With electro-hydraulic operation and for external electronics

Type 4WRZ...-7XJ/...

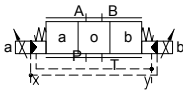

X=external
Y=external

Type 4WRZ...A-7XJ/...

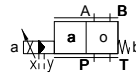

Type 4WRZ...-7XJ/...E...

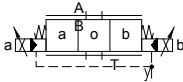

X=external
Y=external

Type 4WRZ...A-7XJ/...E...

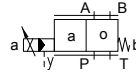

Type 4WRZ...-7XJ/...ET...

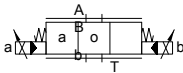

X=external
Y=external

Type 4WRZ...A-7XJ/...ET...

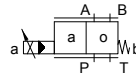

Type 4WRZ...-7XJ/...T...

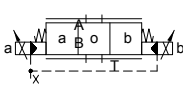

X=external
Y=external

Type 4WRZ...A-7XJ/...T...

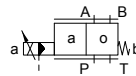

With electro-hydraulic operation and for integrated electronics

Type 4WRZE...-7XJ/...

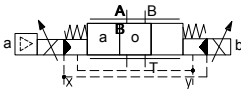

X=external
Y=external

Type 4WRZE...A-7XJ/...

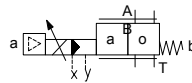

Type 4WRZE...-7XJ/...E...

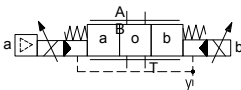

X=external
Y=external

Type 4WRZE...A-7XJ/...E...

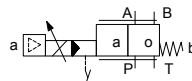

Type 4WRZE...-7XJ/...ET

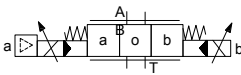

X=external
Y=external

Type 4WRZE...A-7XJ/...ET...

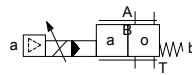

Type 4WRZE...-7XJ/...T...

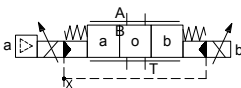

X=external
Y=external

Type 4WRZE...A-7XJ/...T...

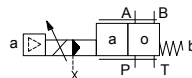

With hydraulic operation

Type 4WRH...-7XJ/...

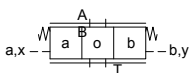

X=external
Y=external

Type 4WRH...A-7XJ/...

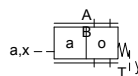

Technical data

General				
Valve type		WRZ		WRZE
Installation		optional, preferably horizontal		
Storage temperature range		°C	-20 to +80	
Ambient temperature range		°C	-20 to +70	-20 to +50
Weight	NG10	kg	7.8	8.0
	NG16	kg	13.4	13.6
	NG25	kg	18.2	18.4
	NG32	kg	42.2	42.4

Hydraulic (measured with HLPAG.p=100bar : 40 °C ± 5 °C)							
Nominal size			10	16	25	32	
Operating pressure	-Pilot valve	External pilot oil supply	bar	30 to 100 bar			
		Internal pilot oil supply	bar	100 to 350 with "D3" only			
	-Main valve		bar	up to 315	up to 350	up to 350	up to 350
Return flow pressure	-Port T (port R) (external pilot oil drain)		bar	up to 315	up to 250	up to 250	up to 150
	-Port T (internal pilot oil drain)		bar	up to 30	up to 30	up to 30	up to 30
	-Port Y		bar	up to 30	up to 30	up to 30	up to 30
Pilot oil volume input signal 0- 100 %			cm ³	1.7	4.6	10	26.5
Pilot oil flow in port X and Y with a stepped input signal 0- 100 %			L/min	3.5	5.5	7	15.9
Flow of the main valve			L/min	up to 170	up to 460	up to 870	up to 1600
Hydraulic fluid				Mineral oil (HL, HLP) to DIN 51524 Further fluids on enquiry!			
Hydraulic fluid temperature range			°C	-20 to +80 (preferably +40 to +50)			
Viscosity range			mm ² /s	20 to 380 (preferably 30 to 46)			
Degree of contamination	Maximum permissible degree of contamination of the pressure fluid is to NAS 1638 or ISO 4406(c)			A filter with a minimum retention rate of $\beta_x \geq 75$ is recommended			
	- Pilot valve	NAS 1638 class 7		x=5			
	- Main valve	NAS 1638 class 9		x=15			
Hysteresis			%	≤ 6			

Electrical				
Valve type		WRZ		WRZE
Type of protection of the valve to EN 60529		IP65 with cable socket mounted and locked		
Voltage type		DC		
Command value overlap		%	15	
Max. current		A	1.5	2.5
Solenoid coil resistance	Cold value at 20°C	Ω	4.8	2
	Max. warm value	Ω	7.2	3
Duty		%	100	
Coil temperature		°C	up to 150	
Valve protection to EN 60529		IP65 with mounted and fixed plug-in connector		

Control electronics				
External amplifier for type WRZ		VT-VSPA2-1-2XJ/...		
Command value signal	-Voltage input "A1"	V	± 10	
	-Current input "F1"	mA	4 to 20	

Electrical connections, plug-in connectors

nominal dimensions in mm

• For type 4WRZ...7XJ (without integrated electronics)

Connections on the component plug

Plug-in connector to DIN EN 175301-803 or ISO 4400

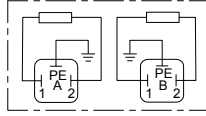

Connections on the plug-in connector

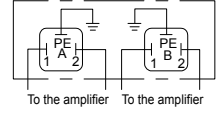

• For type 4WRZE ...7XJ (with integrated electronics (OBE))

For pin allocation also see block circuit diagram.

Plug-in connector to DIN EN 175201-804

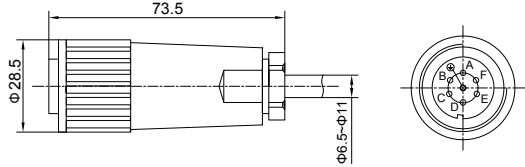

• Integrated control electronics for type 4WRZE ...7XJ

Component plug allocation

	Contact	Interface A1 signal	Interface F1 signal
Supply voltage	A	24 VDC (U(t)=19V to 35V)	
	B	GND	
	C	n.c. ¹⁾	
Differential amplifier input	D	±10V, Re>50KΩ	4 to 20mA, Re>100Ω
	E	reference potential command value	
	F	n.c. ¹⁾	

Connection cable:

Recommended:
 – up to 25 m cable length type LiYCY 5 × 0.75 mm²;
 – up to 50 m cable length type LiYCY 5 × 1.0 mm².
 For outside diameter see plug-in connector sketch.
 Only connect screen to PE on the supply line.

¹⁾ Contacts C and F must not be connected!

Command value:

A positive command value 0 to +10V (or 12 to 20 mA) at D and the reference potential at E results in a flow from P to A and B to T. A negative command value 0 to -10V (or 12 to 4 mA) at D and the reference potential at E results in a flow from P to B and A to T. For a valve with 1 solenoid on side a (e.g. spool variants EA and WA) a positive command value at D and the reference potential at E results in a flow from P to B and A to T.

• Integrated electronics (OBE) for type 4WRZE...7XJ

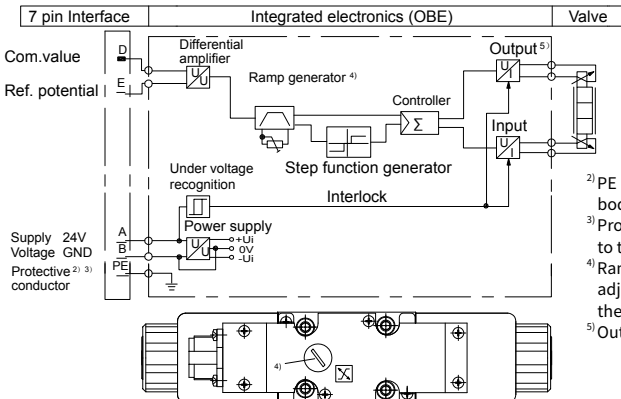

²⁾ PE is connected to the cooling body and the valve housing!

³⁾ Protective conductor screwed to the valve housing and cover.

⁴⁾ Ramp can be externally adjusted from 0 to 2.5s, the same applies for T_{up} and T_{down}.

⁵⁾ Output stages current regulated.

Characteristic curves (measured with spools "E, W6-, EA, W6A" and HLP46, $\vartheta_{oil}=40^{\circ}\text{C} \pm 5^{\circ}\text{C}$, $P=100\text{bar}$)

NG 10

25L/min nominal flow at a 10 bar valve pressure differential

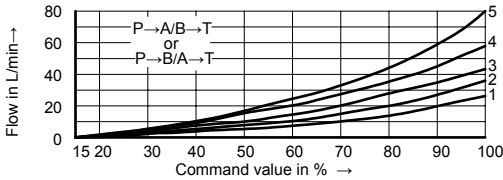

50L/min nominal flow at a 10 bar valve pressure differential

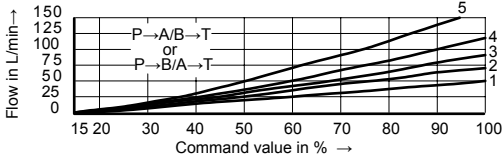

- 1 $\Delta p=10\text{bar}$ constant
- 2 $\Delta p=20\text{bar}$ constant
- 3 $\Delta p=30\text{bar}$ constant
- 4 $\Delta p=50\text{bar}$ constant
- 5 $\Delta p=100\text{bar}$ constant

Δp =Valve pressure differential
(inlet pressure p_p minus load pressure p_l minus return pressure p_r)

85L/min nominal flow at a 10 bar valve pressure differential

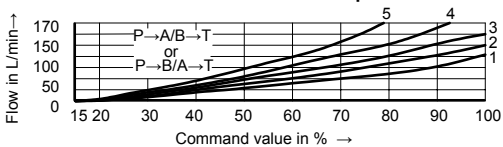

Transient function with a stepped form of electrical input signal $P_{st} = 50\text{bar}$

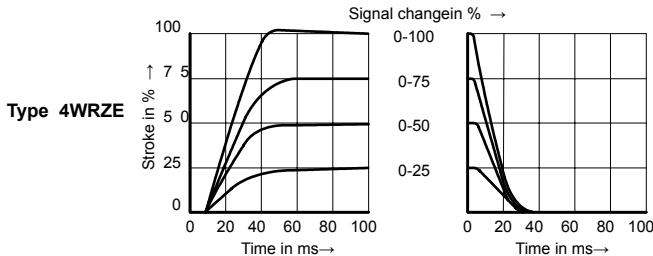
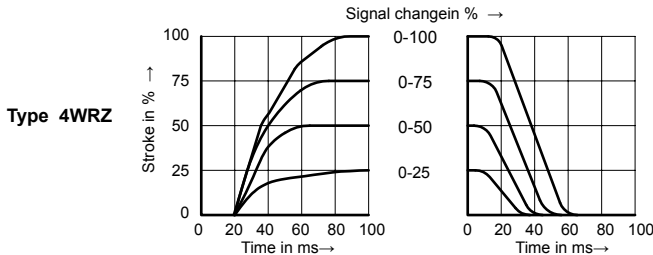

Characteristic curves (measured with spools "E, W6-, EA, W6A" and HLP46, $\vartheta_{oil}=40^{\circ}\text{C} \pm 5^{\circ}\text{C}$, $P=100\text{bar}$)

NG 16

100L/min nominal flow at a 10 bar valve pressure differential

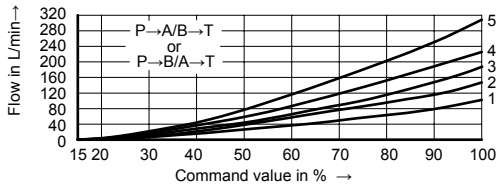

- 1 $\Delta p=10\text{bar}$ constant
- 2 $\Delta p=20\text{bar}$ constant
- 3 $\Delta p=30\text{bar}$ constant
- 4 $\Delta p=50\text{bar}$ constant
- 5 $\Delta p=100\text{bar}$ constant

150L/min nominal flow at a 10 bar valve pressure differential

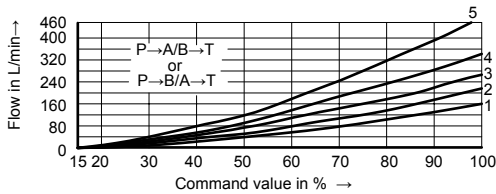

Δp =Valve pressure differential
(inlet pressure p_p minus load pressure p_L minus return pressure p_r)

Transient function with a stepped form of electrical input signal $P_{st}=50\text{bar}$

Type 4WRZ

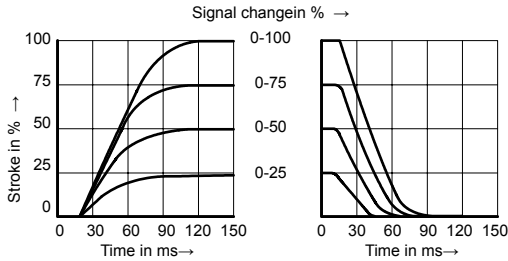

Type 4WRZE

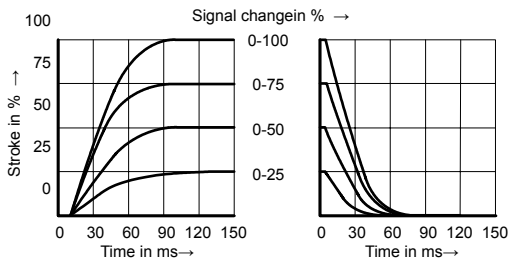

06

Characteristic curves (measured with spools "E, W6-, EA, W6A" and HLP46, $\vartheta_{oil}=40^{\circ}\text{C} \pm 5^{\circ}\text{C}$, $P=100\text{bar}$)

NG 25

220L/min nominal flow at a 10 bar valve pressure differential

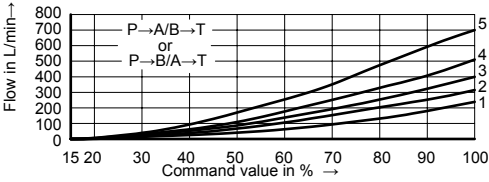

- 1 $\Delta p=10\text{bar}$ constant
- 2 $\Delta p=20\text{bar}$ constant
- 3 $\Delta p=30\text{bar}$ constant
- 4 $\Delta p=50\text{bar}$ constant
- 5 $\Delta p=100\text{bar}$ constant

325L/min nominal flow at a 10 bar valve pressure differential

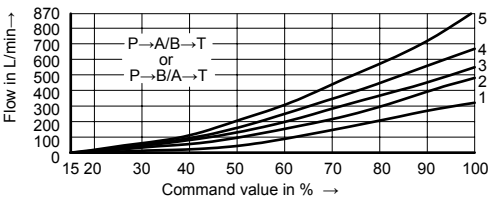

Δp =Valve pressure differential
(inlet pressure p_p minus load pressure p_l minus return pressure p_r)

Transient function with a stepped form of electrical input signal $P_{st} = 50\text{bar}$

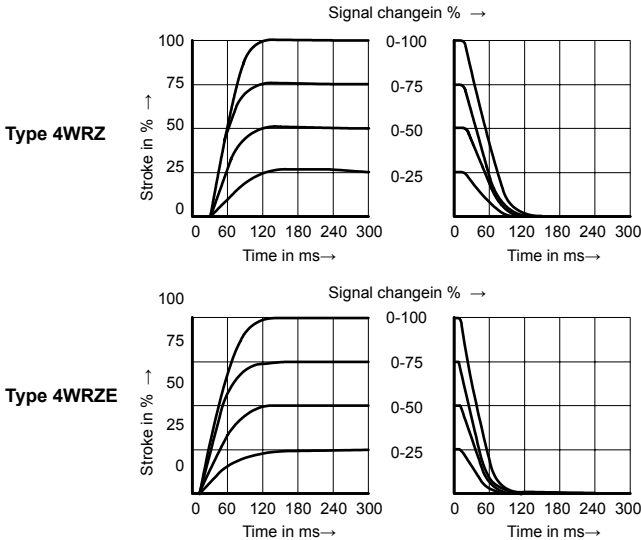

Characteristic curves (measured with spools "E, W6-, EA, W6A" and HLP46, $\vartheta_{oil}=40^{\circ}\text{C} \pm 5^{\circ}\text{C}$, $P=100\text{bar}$)

NG 32

360L/min nominal flow at a 10 bar valve pressure differential

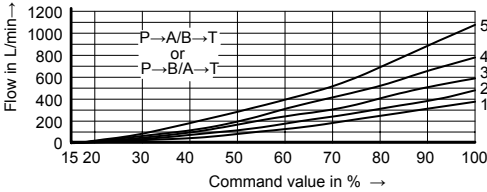

- 1 $\Delta p=10\text{bar}$ constant
- 2 $\Delta p=20\text{bar}$ constant
- 3 $\Delta p=30\text{bar}$ constant
- 4 $\Delta p=50\text{bar}$ constant
- 5 $\Delta p=100\text{bar}$ constant

520L/min nominal flow at a 10 bar valve pressure differential

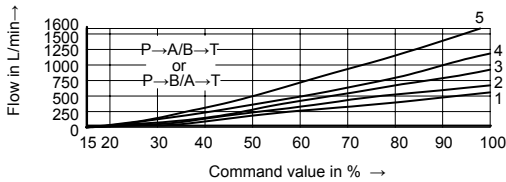

Δp =Valve pressure differential
(inlet pressure p_p minus load pressure p_L minus return pressure p_r)

Transient function with a stepped form of electrical input signal $P_{st} = 50\text{bar}$

Signal changein % \rightarrow

Type 4WRZ

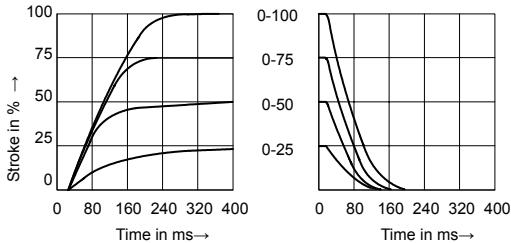

Type 4WRZE

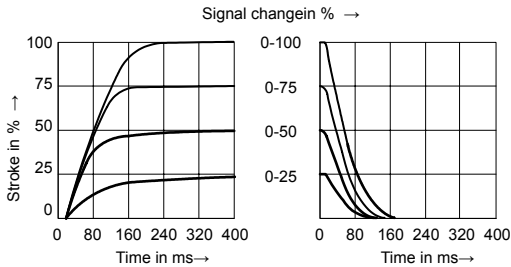

Unit dimensions

(Dimensions in mm)

NG 10

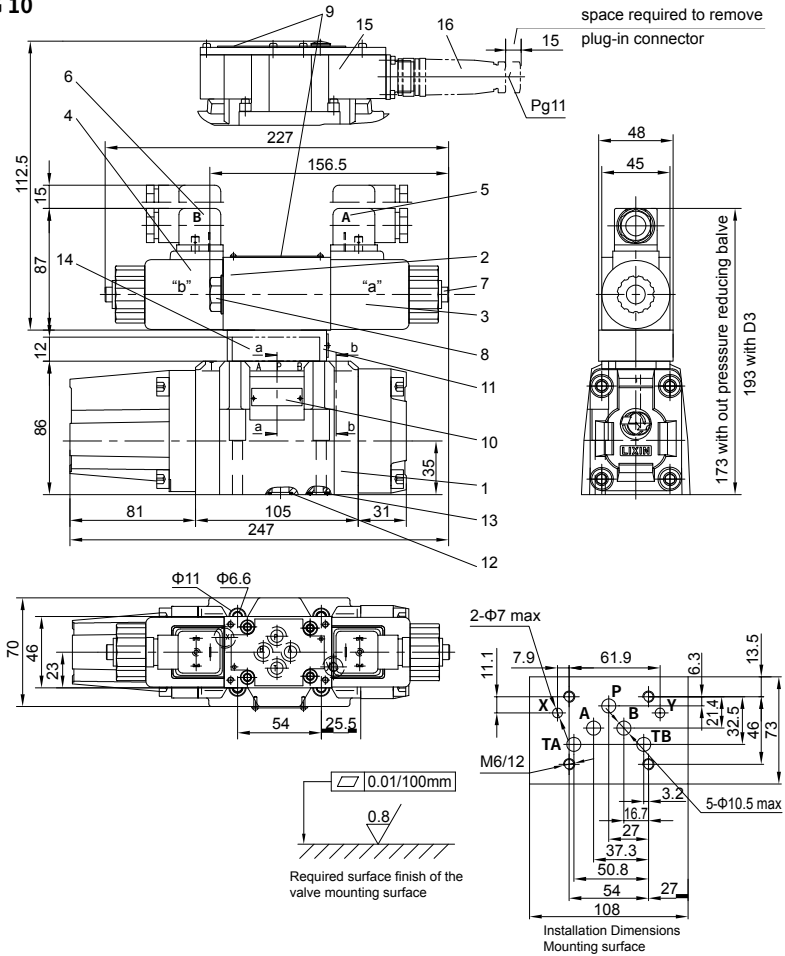

- | | |
|---|--|
| <ul style="list-style-type: none"> 1 Main valve 2 Pilot valve 3 Proportional solenoid "a" 4 Proportional solenoid "b" 5 Cable socket "A" 6 Cable socket "B" 7 Concealed manual override "N" 8 Cover for valves with one solenoid 9 Nameplate for pilot valve 10 Name plate for main valve | <ul style="list-style-type: none"> 11 Pressure reducing valve "D3" 12 Identical seal rings for ports A, B, P and T)
(R-ring $13 \times 1.6 \times 2$ or O-ring 12×2) 13 Identical seal rings for ports X and Y)
(R-ring $11.18 \times 1.6 \times 1.78$ or O-ring 10.82×1.78) 14 Interconnection plate (type 4WRH...) 15 Integrated electronics (OBE) 16 Plug-in connector to DIN EN 175201-804 |
|---|--|

Unit dimensions

(Dimensions in mm)

NG 16

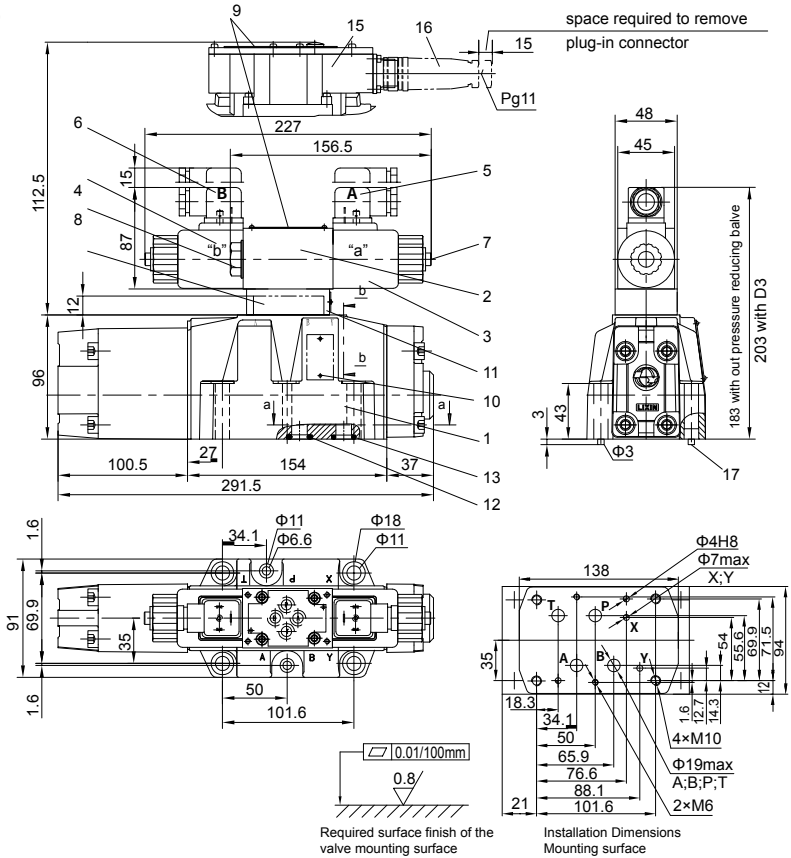

- 1 Main valve
- 2 Pilot valve
- 3 Proportional solenoid "a"
- 4 Proportional solenoid "b"
- 5 Cable socket "A"
- 6 Cable socket "B"
- 7 Concealed manual override "N"
- 8 Cover for valves with one solenoid
- 9 Nameplate for pilot valve
- 10 Nameplate for main valve

- 11 Pressure reducing valve "D3"
- 12 Identical seal rings for ports A, B, P and T)
(R-ring 22.53×2.3×2.62 or O-ring 22×2.5)
- 13 Identical seal rings for ports X and Y)
(R-ring 12×2×2 or O-ring 10×2)
- 14 Interconnection plate (type 4WRH...)
- 15 Integrated electronics (OBE)
- 16 Plug-in connector to DIN EN 175201-804
- 17 Locating pin

Unit dimensions

(Dimensions in mm)

NG 25

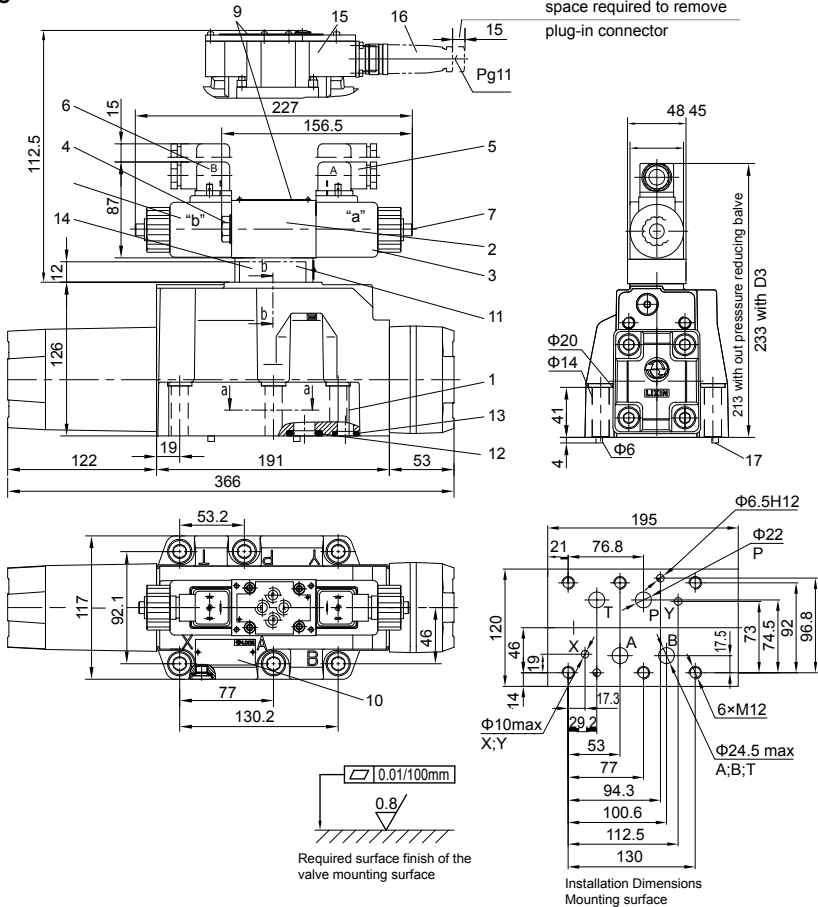

- | | |
|--|---|
| <ul style="list-style-type: none"> 1 Main valve 2 Pilot valve 3 Proportional solenoid "a" 4 Proportional solenoid "b" 5 Cable socket "A" 6 Cable socket "B" 7 Concealed manual override "N" 8 Cover for valves with one solenoid 9 Nameplate for pilot valve 10 Nameplate for main valve | <ul style="list-style-type: none"> 11 Pressure reducing valve "D3" 12 Identical seal rings for ports A, B, P and T
(R-ring 27.8×2.6×3 or O-ring 27×3) 13 Identical seal rings for ports X and Y
(R-ring 19×3×3 or O-ring 19×3) 14 Interconnection plate (type 4WRH...) 15 Integrated electronics (OBE) 16 Plug-in connector to DIN EN 175201-804 17 Locating pin |
|--|---|

Unit dimensions

(Dimensions in mm)

NG 32

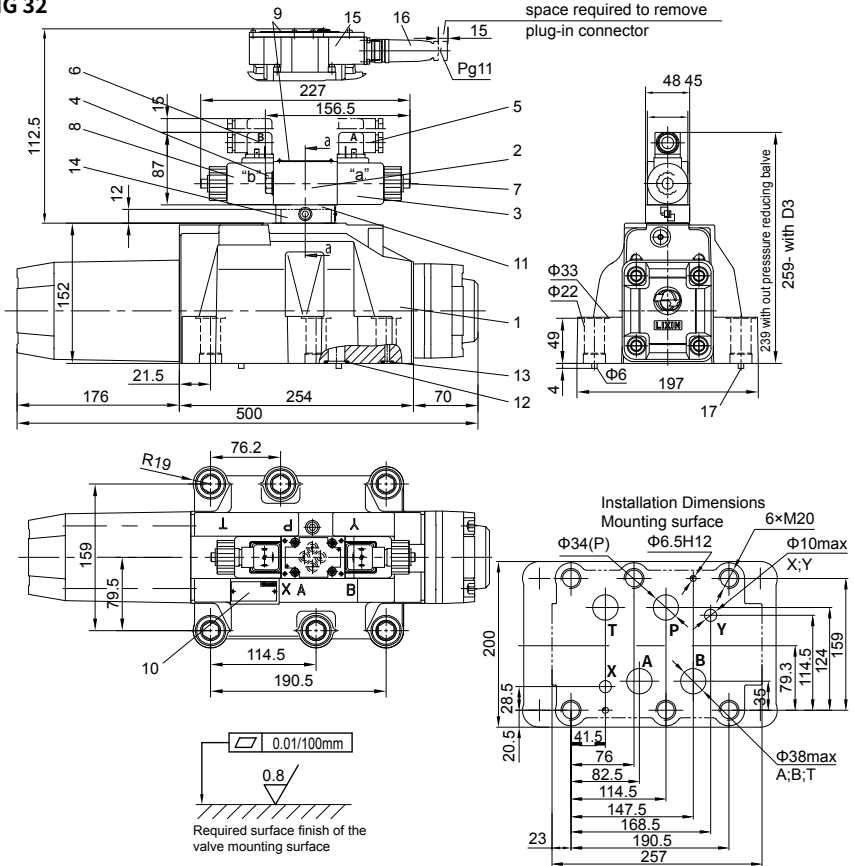

- 1 Main valve
- 2 Pilot valve
- 3 Proportional solenoid "a"
- 4 Proportional solenoid "b"
- 5 Cable socket "A"
- 6 Cable socket "B"
- 7 Concealed manual override "N"
- 8 Cover for valves with one solenoid
- 9 Nameplate for pilot valve
- 10 Nameplate for main valve

- 11 Pressure reducing valve "D3"
- 12 Identical seal rings for ports A, B, P and T (R-ring 42.5×3×3 or O-ring 42×3)
- 13 Identical seal rings for ports X and Y (R-ring 19×3×3 or O-ring 19×3)
- 14 Interconnection plate (type 4WRH...)
- 15 Integrated electronics (OBE)
- 16 Plug-in connector to DIN EN 175201-804
- 17 Locating pin