



# 4WRE(E)...type Proportional Directional Valve



## 4WRE and 4WREE...type

Size 6, 10

Max. Working Pressure: 315 bar

Max. Flow: 80 L/min (size 6)

180 L/min (size 10)

### Contents

Function and configuration	02
Symbols	03
Ordering code	03
Technical data	04
Electrical connections, plug-in connectors	05
Integrated electronics	06-07
Characteristic curves	07-10
Unit dimensions	11-14

### Features

- Direct operated proportional directional valve with electrical position feedback
- Closed loop control of the direction and size of a flow
- Operation is by proportional solenoids with a central thread and removable coil
- For subplate mounting: Porting pattern conforms to ISO 4401
- Spring centred control spool
- Integrated electronics (OBE) with voltage input or current input (A1 resp. F1)
- 4WRE separate order:  
analogue module amplifier

## Function and configurations

4WRE(E) type proportional valve is designed as direct operated devices in plate design. Operation is effected by proportional solenoids with central thread and detachable coil. The solenoids are optionally controlled by either external electronics (type 4WRE) or by the integrated electronics (type 4WREE).

The valve consists of Housing (1), Compression springs (2), Control spool (3), and Solenoid (4 and 5) with central thread, Solenoid(5) with position transducer and optional integrated control electronics (6).

In the de-energised condition the spool (3) is held in a mechanical centre position by the solenoid return springs (2).

– With the solenoids (4), de-energised, the control spool (3) is held in the central position by the compression springs (2).

– Direct operation of the control spool (3) by energising one of the proportional solenoids (4, 5) e.g. control of solenoid right, then movement of the control spool (3) to the left in proportion to the electrical input signal, and connection from P to A and B to T via orifice-like crosssections with progressive flow characteristics.

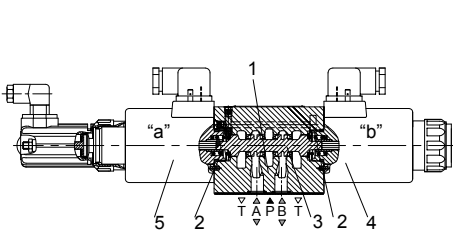

Type 4WRE 10...-2XJ/...

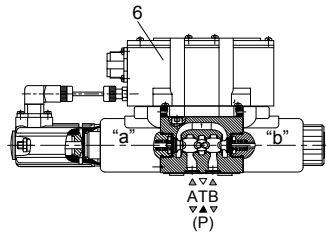

Type 4WREE 6...-2XJ/...

4WRE(E)...A-2XJ the 2 switched position valves are however only fitted with solenoid "a".

A plug (7) is fitted in place on the "b" proportional solenoid.

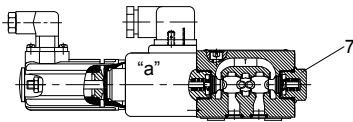

Type 4WRE 6...A-2XJ/...

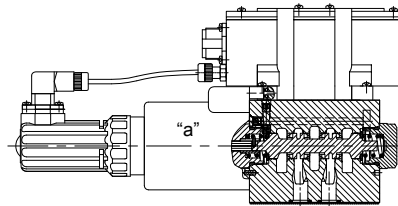

Type 4WREE 10...A-2XJ/...

# Symbols

## Without integrated electronics

Type 4WRE...-2XJ/...

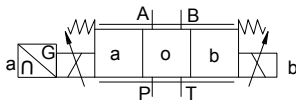

Type 4WRE...A-2XJ/...

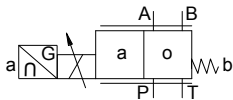

## With integrated electronics

Type 4WREE...-2XJ/...

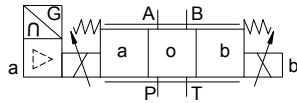

Type 4WREE...A-2XJ/...

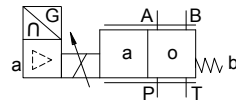

# Ordering code

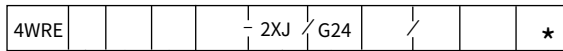

Without integrated = No code  
 With integrate = E  
 Nominal size 6 =6  
 Nominal size 10 =10

### Spool symbols

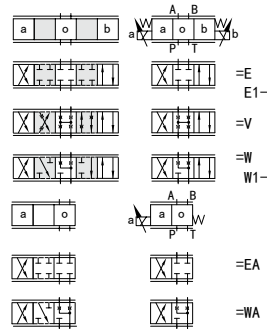

□ Transitional symbols

With symbols E1- and W1-: P → A:

$Q_{v,max}$  B → T:  $q_v/2$

P → B:  $q_v/2$  A → T:  $q_{v,max}$

Further information  
 in plain text

V = FKM  
 No code = NBR

No code = For 4WRE:  
 Interface A1 or F1 for 4WREE:  
 A1= Command value input ±10V  
 F1= Command value input 4 to 20mA

4WRE: Z4= With plug-in connector  
 K4= Without plug-in connector  
 4WREE: K31= Without plug-in connector  
 Z31= With plug-in connector

Power supply voltage of electric control device:  
 G24= Power supply voltage 24VDC

2XJ= Series 20J~29J  
 (20J to 29J unchanged installation and connection dimensions)

Nominal flow at a valve pressure differential	$\Delta P=10\text{bar}$
NG 6: 08=	8L/min
16=	16L/min
32=	32L/min
NG 10: 25=	25L/min
50=	50L/min
75=	75L/min

## Technical data

<b>1. Hydraulic</b>			
Installation			Optional, preferably horizontal
Nominal size			6      10
Weight	4WRE...2XJ	Kg	2.2
	4WREE...2XJ		6.3
Nominal flow $q_{nom}$ at $\Delta p = 10$ bar			L/min      8, 16, 32      25, 50, 75
Hysteresis			% $\leq 0.1$
Reversal span			% $\leq 0.05$
Response sensitivity			% $\leq 0.05$
Max.operating pressure	Ports A, B, P	bar	315
	Port T	bar	210
Pressure fluid			Mineral oil (HL, HLP) to DIN 51524 Other pressure fluids on request!
Ambient air temperature range	4WRA...2XJ	°C	-20°C to 70°C (-4° F to 158° F)
	4WRAE...2XJ	°C	-20°C to 50°C (-4° F to 122° F)
Viscosity range			mm <sup>2</sup> /s      20 to 380 (preferably 30 to 46)
Fluid Cleanliness Class			NAS1638 class9 or ISO 4406 class 20/18/15

<b>2. Electrical</b>			
<b>1) Solenoid data</b>			
Nominal size			6      10
Voltage type			DC
Command value signal for 4WREE			$\pm 10V$ or 4 ~ 20mA
Max.current per solenoid			A      2.5
Solenoid coil resistance	Cold value	$\Omega$	2.7
	Max.warm value		3.7
Duty			%      ED100%
Max.coil temperature			°C      150
Valve protection to EN 60529			IP 65
<b>2) Control electronics</b>			
Amplifier	4WRE...2XJ	VT-VSPA2-...-2XJ	
	4WREE...2XJ	integrated in the valve(OBE)	
Supply voltage	Nominal voltage	VDC	24
	Lower limiting value	V	19.4
	Upper limiting value	V	35
Amplifier power consumption	I <sub>max</sub>	A	< 2
	Impulse current	A	3

# Electrical connections, plug-in connectors

nominal dimensions in mm

## • For type 4WRE...2XJ (without integrated electronics)

### Connections on the component plug

Plug-in connector to DIN EN 175301-803 or ISO 4400

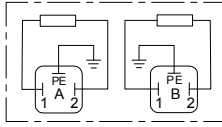

### Connections on the plug-in connector

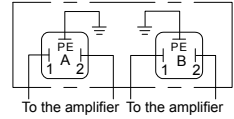

## • For type 4WREE...2XJ (with integrated electronics (OBE))

For pin allocation also see block circuit diagram.

Plug-in connector to DIN EN 175201-804

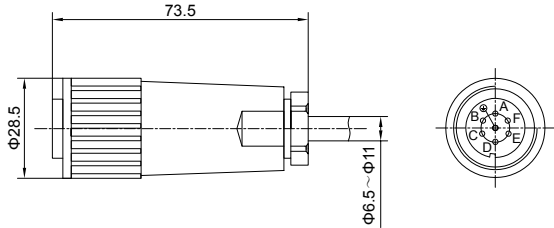

## • Inductive position sensor

### Coil wiring

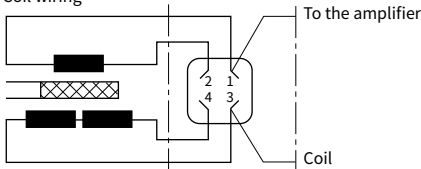

### connect to the plug

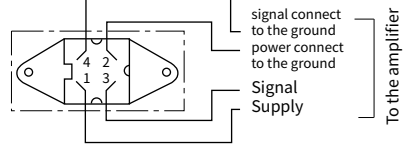

Plug connector 4 pin Pg7-G4W1F

### Connecting cables:

**Recommend:** For cables up to 50 m in length, Please use a cable of type LiYCY 4×0.25 mm<sup>2</sup> Connect the shield to the PE only on the supply side.

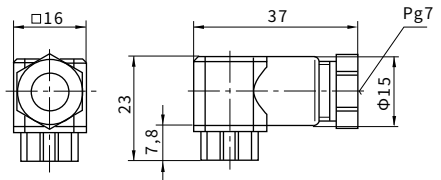

# Integrated control electronics for type 4WREE

## Component plug allocation

	Contact	Interface A1 signal	Interface F1 signal
Supply voltage	A	24 VDC(U(t)=19.4V to 35V), I <sub>max</sub> =2A	
	B	0V	
Reference potential (actual value)	C	ref.contact F, Re>50KΩ	ref.contact F, Re<10Ω
Differential amplifier input	D	±10V, Re>50KΩ	4 to 20mA, Re>100Ω
	E	Reference potential command value	
Measurement output (actual value)	F	±10 V actual value (limiting load 5 mA)	4 to 20 mA actual value, load resistance max.300Ω
	PE	Connected with cooling body and valve housing	

**Command value:** A positive command value 0 to +10V (or 12 to 20 mA) at D and the reference potential at E results in a flow from P to A and B to T.  
 A negative command value 0 to -10V (or 12 to 4 mA) at D and the reference potential at E results in a flow from P to B and A to T.  
 For a valve with 1 solenoid on side a (e.g. spool variants EA and WA) a positive command value at D and the referencepotential at E results in a flow from P to B and A to T.

**Actual value:** A positive actual value 0 to +10V (or 12 to 20mA) at F and the reference potential at C results in flow from P to A and B to T,  
 A negative actual value 0 to -10V (or 4 to 12mA) at F and the reference potential at C results in flow from P to B and A to T.  
 With valves with 1 solenoid, a positive actual valueat F and referencepotential at C results in flow from P to B and A to T.

**Connection cable:** Recommended: - up to 25 m cable length type LiYCY 7×0.75 mm<sup>2</sup>  
 - up to 50 m cable length type LiYCY 7×1.0 mm<sup>2</sup>  
 For outside diameter see plug-in connector sketch  
 Only connect screen to PE on the supply line.

## Integrated electronics (OBE) for type 4WREE...2XJ

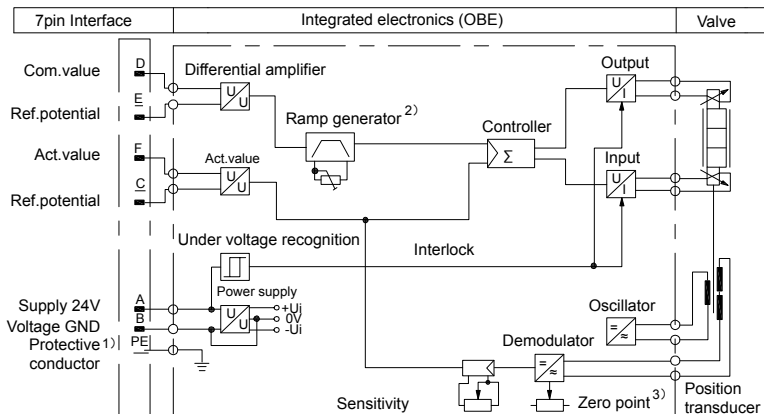

# Integrated control electronics for type 4WREE

- 1) The protective conductor (PE) is connected to the cooling body and the valve housing!
- 2) The ramp is externally adjustable from 0 to 2.5 s, the same applies for  $T_{up}$  and  $T_{down}$ .
- 3) Zero point is externally adjustable.

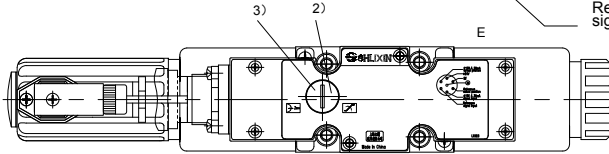
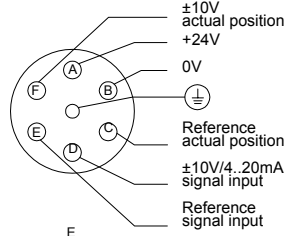

## Characteristic curves

(measured with HLP46,  $\vartheta_{oil} = 40^\circ\text{C} \pm 5^\circ\text{C}$ )

### • Type 4WREE (NG 6 and 10)

Pressure-signal-characteristic curves (V spool,  $P_s = 100 \text{ bar}$ )

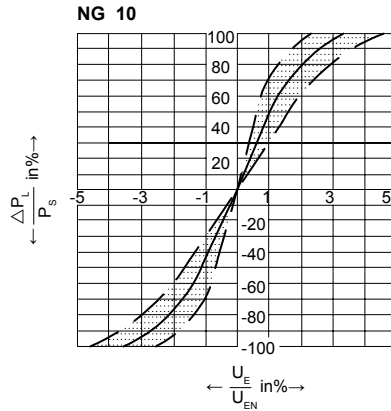
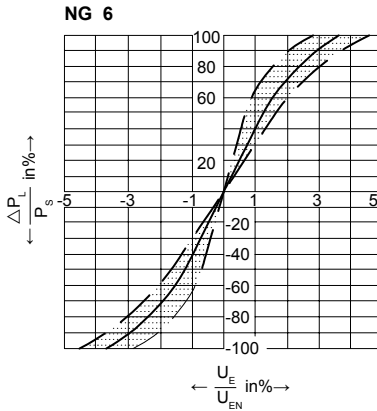

### Leakage flow with the spool in the central position

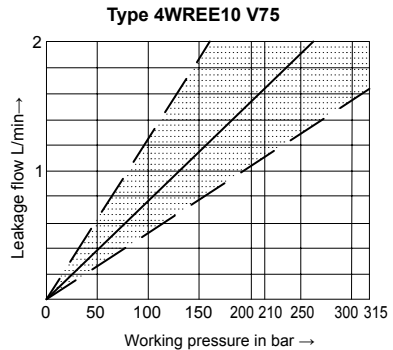
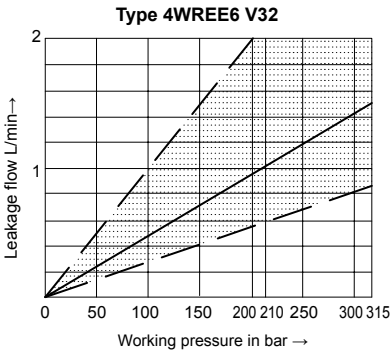

06

# Characteristic curves (measured with HLP46, $\vartheta_{oil}=40^{\circ}\text{C} \pm 5^{\circ}\text{C}$ , $P=100\text{bar}$ )

## • Type 4WREE (NG 6 and 10)

### NG 6

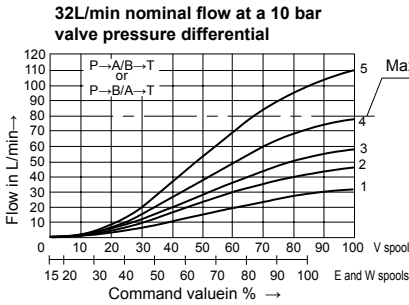
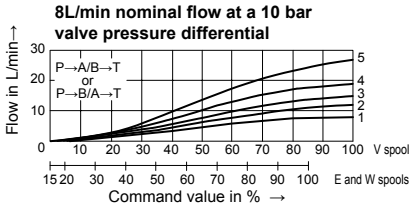

**16L/min nominal flow at a 10 bar valve pressure differential**

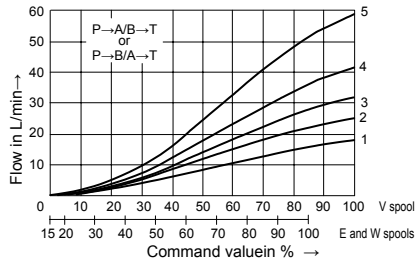

- 1  $\Delta p=10\text{bar}$  constant
- 2  $\Delta p=20\text{bar}$  constant
- 3  $\Delta p=30\text{bar}$  constant
- 4  $\Delta p=50\text{bar}$  constant
- 5  $\Delta p=100\text{bar}$  constant

$\Delta p$ =Valve pressure differential  
(inlet pressure  $p_p$  minus load pressure  $p_L$  minus return pressure  $p_T$ )

### NG 10

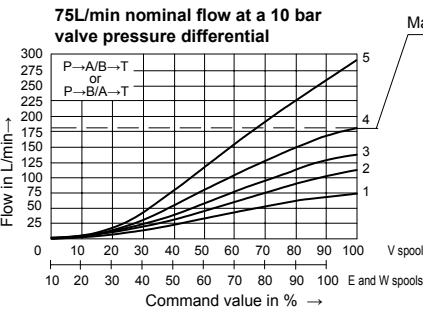
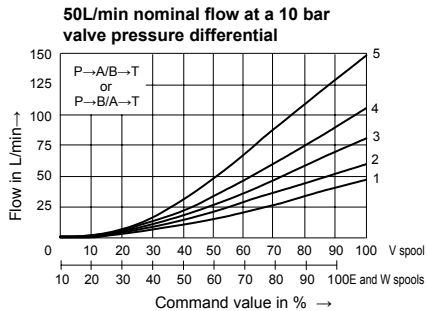
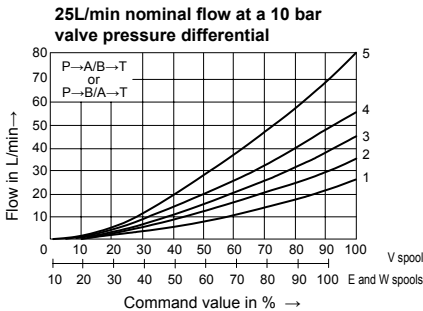

- 1  $\Delta p=10\text{bar}$  constant
- 2  $\Delta p=20\text{bar}$  constant
- 3  $\Delta p=30\text{bar}$  constant
- 4  $\Delta p=50\text{bar}$  constant
- 5  $\Delta p=100\text{bar}$  constant

$\Delta p$ =Valve pressure differential  
(inlet pressure  $p_p$  minus load pressure  $p_L$  minus return pressure  $p_T$ )



# Characteristic curves

(measured with HLP46,  $\vartheta_{oil}=40^{\circ}\text{C} \pm 5^{\circ}\text{C}$ ,  $P=100\text{bar}$ )

## • Type 4WREE (NG 6)

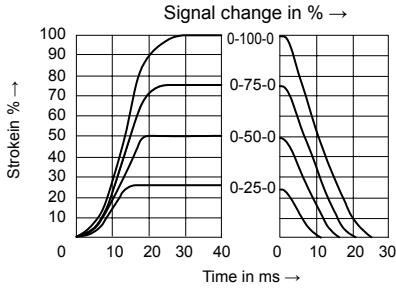

### Transient function with a stepped form of electrical input signal

4/3 valve version,  
Spool symbol "E"

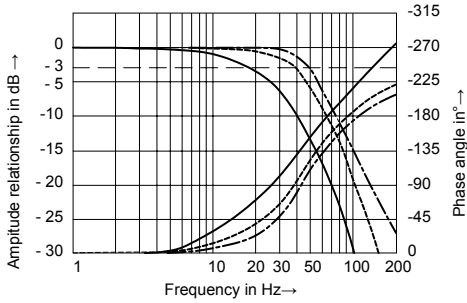

### Frequency response characteristic curves

4/3 valve version,  
Spool symbol "V"

- Signal  $\pm 10\%$
- ..... Signal  $\pm 25\%$
- Signal  $\pm 100\%$

### Flow-pressure differential curve

Load function with maximum valve opening.  
Nominal flows 8, 16 and 32 L/min.  
Spool symbol "V"

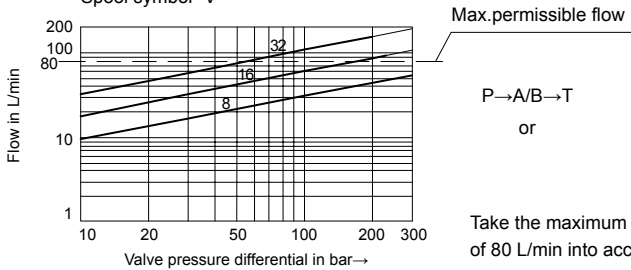

P → A/B → T  
or

Take the maximum permissible flow  
of 80 L/min into account!

# Characteristic curves

(measured with HLP46,  $\vartheta_{oil} = 40^{\circ}\text{C} \pm 5^{\circ}\text{C}$ ,  $P=100\text{bar}$ )

## • Type 4WREE (NG 10)

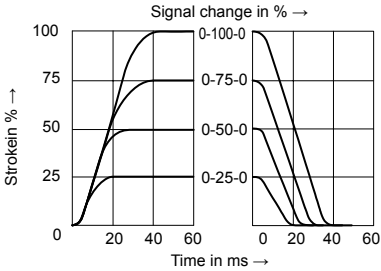

**Transient function with a stepped form of electrical input signal**

4/3 valve version,  
Spool symbol "E"

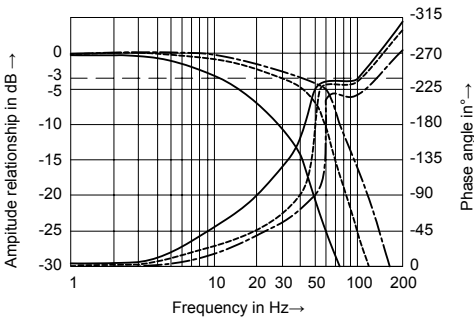

**Frequency response characteristic curves**

4/3 valve version,  
Spool symbol "V"

- Signal  $\pm 10\%$
- ..... Signal  $\pm 25\%$
- Signal  $\pm 100\%$

### Flow-pressure differential curve

Load function with maximum valve opening.  
Nominal flows 25, 50 and 75 L/min.  
Spool symbol "V"

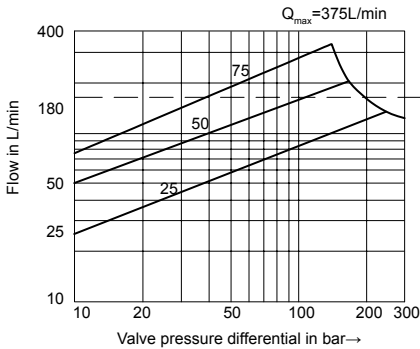

Max. permissible flow

P → A/B → T

or

P → B/A → T

Take the maximum permissible flow  
of 180 L/min into account!

# Unit dimensions

(nominal dimensions in mm)

## Type 4WRE6...2XJ

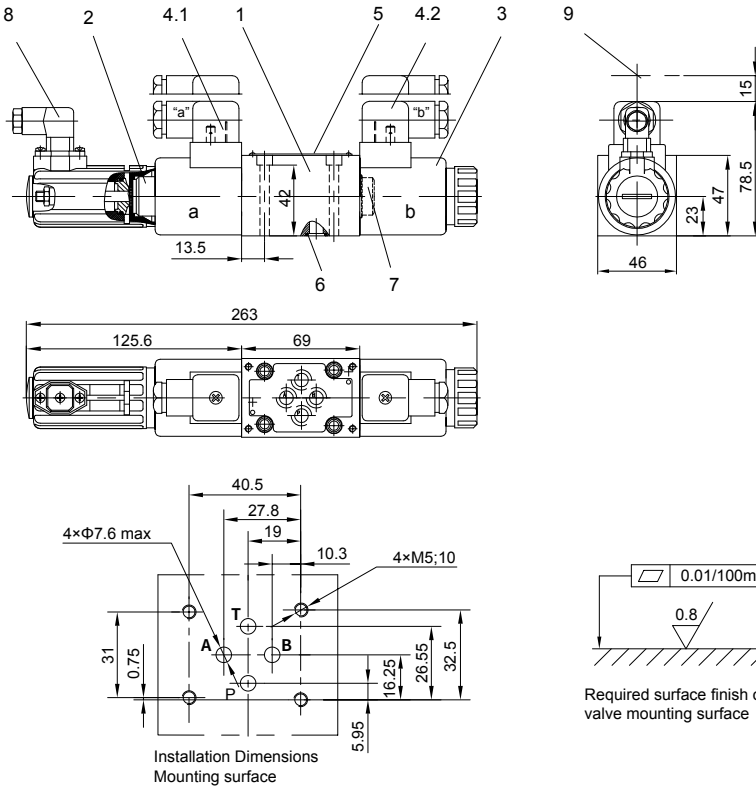

- |   |   |
|---|---|
| <ul style="list-style-type: none"> <li>1 Valve housing</li> <li>2 Proportional solenoid "a" with inductive position transducer</li> <li>3 Proportional solenoid "b"</li> <li>4.1 Plug-in connector "A"</li> <li>4.2 Plug-in connector "B"</li> <li>5 Name plate</li> <li>6 Identical seal rings for ports A, B, P and T (R-ring 9.81 × 1.5 × 1.78 or O-ring 9.25 × 1.78)</li> </ul> | <ul style="list-style-type: none"> <li>7 Plug for valves with one solenoid (2 switching positions, versions EA or WA)</li> <li>8 Plug-in connector for inductive position transducer</li> <li>9 Space required to remove the plug-in connector</li> </ul> |
|---|---|

## Unit dimensions

(nominal dimensions in mm)

### Type 4WREE6...2XJ

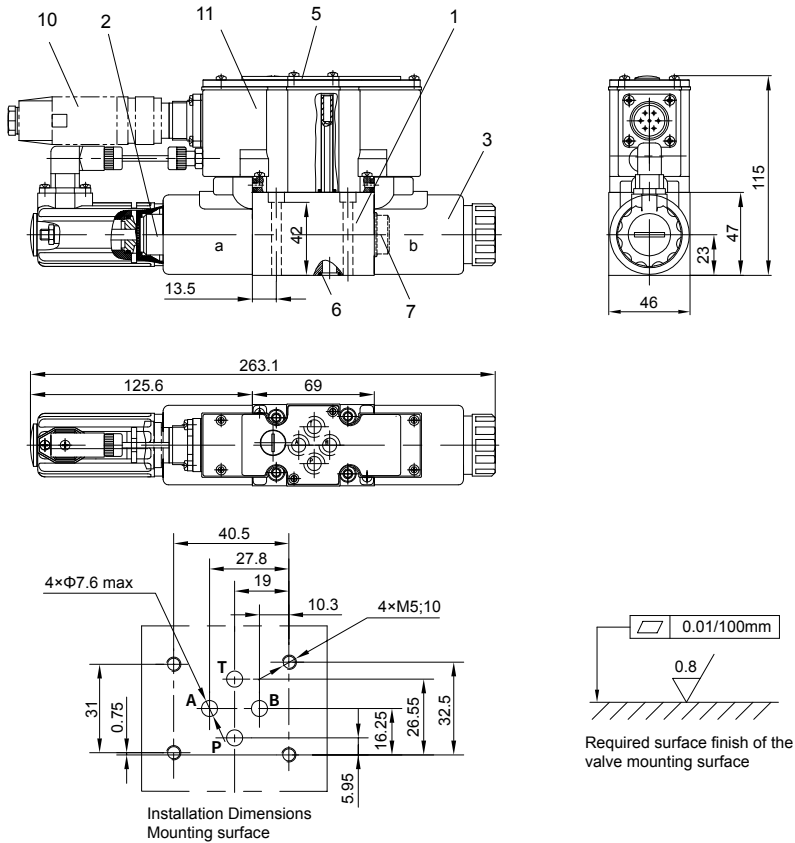

- 1 Valve housing
- 2 Proportional solenoid "a" with inductive position transducer
- 3 Proportional solenoid "b"
- 5 Name plate
- 6 Identical seal rings for ports A, B, P and T  
(R-ring  $9.81 \times 1.5 \times 1.78$  or O-ring  $9.25 \times 1.78$ )
- 7 Plug for valves with one solenoid  
(2 switching positions, versions EA or WA)
- 10 Plug-in connector
- 11 Integrated electronics (OBE)

# Unit dimensions

(nominal dimensions in mm)

## Type 4WRE10...2XJ

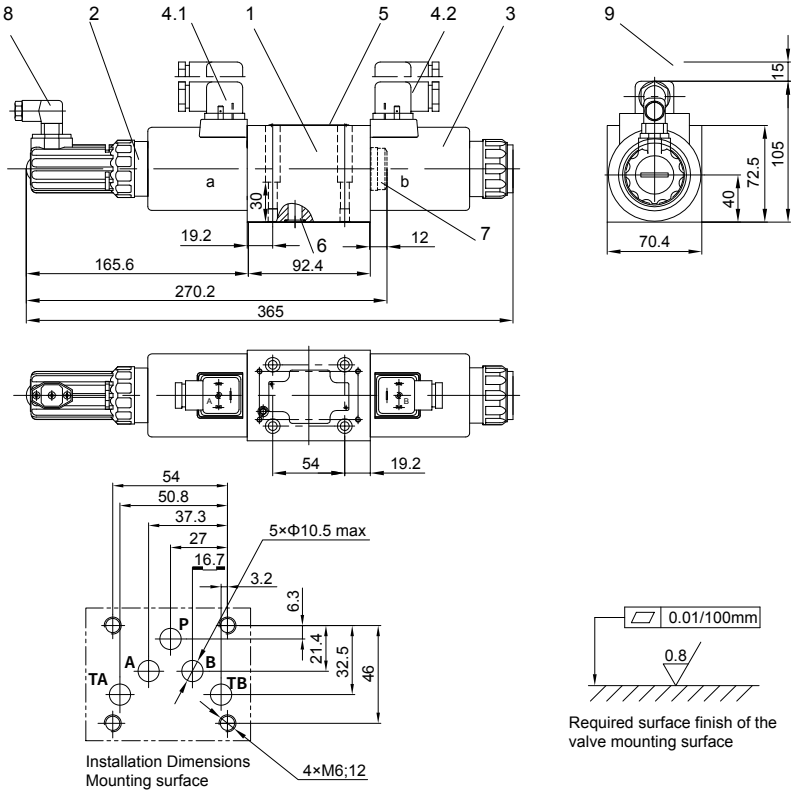

- 1 Valve housing
- 2 Proportional solenoid "a" with inductive position transducer
- 3 Proportional solenoid "b"
- 4.1 Plug-in connector "A"
- 4.2 Plug-in connector "B"
- 5 Name plate
- 6 Identical seal rings for ports A, B, P and T  
(R-ring 13×1.6×2 or O-ring 12×2)
- 7 Plug for valves with one solenoid  
(2 switching positions, versions EA or WA)
- 8 Plug-in connector for inductive position transducer
- 9 Space required to remove the plug-in connector

## Unit dimensions

(nominal dimensions in mm)

### Type 4WREE10...2XJ

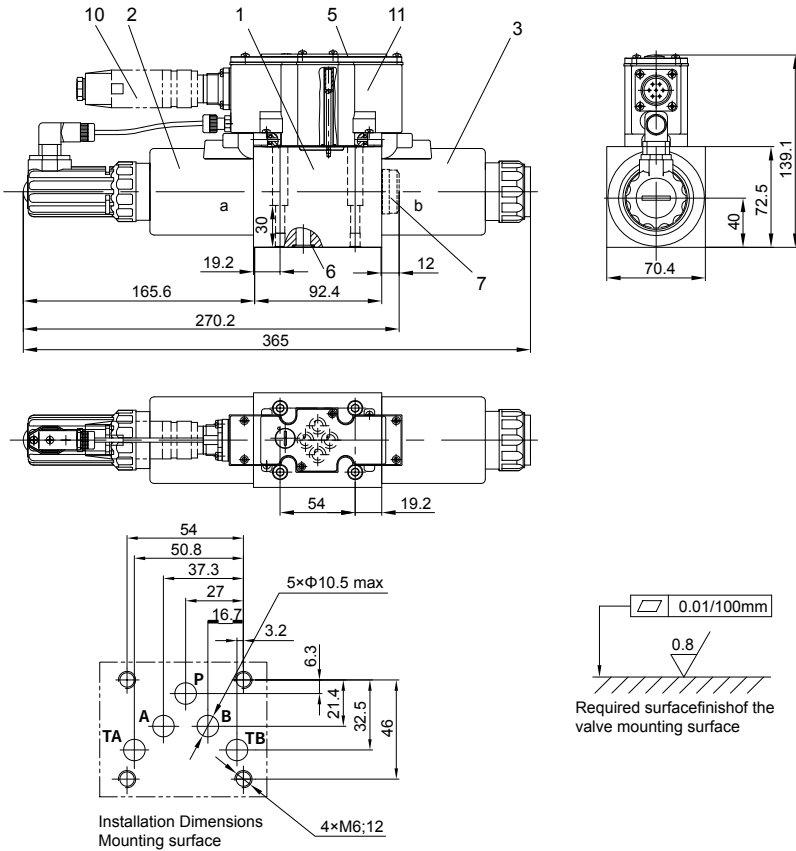

- 1 Valve housing
- 2 Proportional solenoid "a" with inductive position transducer
- 3 Proportional solenoid "b"
- 4 Name plate
- 5 Identical seal rings for ports A, B, P and T (R-ring 13×1.6×2 or O-ring 12×2)
- 6 Plug for valves with one solenoid (2 switching positions, versions EA or WA)
- 7 Plug-in connector
- 8 Integrated electronics (OBE)